

MERC Smart PV Optimizer

User Manual

Issue 07
Date 2024-05-06



Copyright © Huawei Digital Power Technologies Co., Ltd. 2024. All rights reserved.

No part of this document may be reproduced or transmitted in any form or by any means without prior written consent of Huawei Digital Power Technologies Co., Ltd.

Trademarks and Permissions



HUAWEI and other Huawei trademarks are the property of Huawei Technologies Co., Ltd.

All other trademarks and trade names mentioned in this document are the property of their respective holders.

Notice

The purchased products, services and features are stipulated by the contract made between Huawei Digital Power Technologies Co., Ltd. and the customer. All or part of the products, services and features described in this document may not be within the purchase scope or the usage scope. Unless otherwise specified in the contract, all statements, information, and recommendations in this document are provided "AS IS" without warranties, guarantees or representations of any kind, either express or implied. The information in this document is subject to change without notice. Every effort has been made in the preparation of this document to ensure accuracy of the contents, but all statements, information, and recommendations in this document do not constitute a warranty of any kind, express or implied.

Huawei Digital Power Technologies Co., Ltd.

Address: Huawei Digital Power Antuoshan Headquarters
Futian, Shenzhen 518043
People's Republic of China

Website: <https://e.huawei.com>

About This Document

Purpose

This document describes the functions, electrical specifications, and structure of the smart photovoltaic (PV) optimizer.

Figures provided in this document are for reference only.





Intended Audience

This document is intended for:

- Sales engineers
- Technical support engineers
- Maintenance engineers

Symbol Conventions

The symbols that may be found in this guide are defined as follows.

Symbol	Description
	Indicates a hazard with a high level of risk which, if not avoided, will result in death or serious injury.
	Indicates a hazard with a medium level of risk which, if not avoided, could result in death or serious injury.
	Indicates a hazard with a low level of risk which, if not avoided, could result in minor or moderate injury.
	Indicates a potential hazard which, if not avoided, could result in equipment damage, data loss, performance deterioration, or unanticipated results. NOTICE is used to address practices not related to personal injury.

Symbol	Description
 NOTE	Supplements the important information in the main text. NOTE is used to address information not related to personal injury, equipment damage, and environment deterioration.

Change History

Changes between document issues are cumulative. The latest document issue contains all updates made in previous issues.

Issue 07 (2024-05-06)

- Updated [2.2 Structure](#).
- Updated [2.3 Configuration Principles](#).
- Updated [3.1 Setting the Physical Layout of the Smart PV Optimizers](#).
- Updated [3.2 Detecting Optimizer Disconnection](#).
- Updated [3.5 Replacing an Optimizer](#).
- Updated [3.6 Maintaining PV Modules](#).

Issue 06 (2023-09-11)

Updated [2.3 Configuration Principles](#).

Issue 05 (2023-03-31)

- Updated [1 Safety Information](#).
- Updated [2.3 Configuration Principles](#).
- Updated [3 System Maintenance](#).

Issue 04 (2023-02-10)

- Updated [2.4 Application Scenarios](#).
- Updated [3.1 Setting the Physical Layout of the Smart PV Optimizers](#).

Issue 03 (2022-11-30)

- Updated [2.2 Structure](#).
- Updated [2.3 Configuration Principles](#).
- Updated [2.4 Application Scenarios](#).
- Updated [3.1 Setting the Physical Layout of the Smart PV Optimizers](#).
- Updated [3.2 Detecting Optimizer Disconnection](#).
- Updated [3.5 Replacing an Optimizer](#).

Issue 02 (2022-09-20)

- Updated [2.3 Configuration Principles](#).
- Updated [3.4 Troubleshooting](#).
- Updated [4 Technical Specifications](#).

Issue 01 (2022-08-30)

This issue is the first official release.

Contents

About This Document.....	ii
1 Safety Information.....	1
1.1 Personal Safety.....	2
1.2 Electrical Safety.....	4
1.3 Environment Requirements.....	8
1.4 Mechanical Safety.....	9
2 Product Introduction.....	14
2.1 Overview.....	14
2.2 Structure.....	15
2.3 Configuration Principles.....	16
2.4 Application Scenarios.....	18
3 System Maintenance.....	20
3.1 Setting the Physical Layout of the Smart PV Optimizers.....	20
3.2 Detecting Optimizer Disconnection.....	22
3.3 Rapid Shutdown.....	23
3.4 Troubleshooting.....	24
3.5 Replacing an Optimizer.....	25
3.6 Maintaining PV Modules.....	27
4 Technical Specifications.....	30
A Acronyms and Abbreviations.....	32

1 Safety Information

Statement

Before transporting, storing, installing, operating, using, and/or maintaining the equipment, read this document, strictly follow the instructions provided herein, and follow all the safety instructions on the equipment and in this document. In this document, "equipment" refers to the products, software, components, spare parts, and/or services related to this document; "the Company" refers to the manufacturer (producer), seller, and/or service provider of the equipment; "you" refers to the entity that transports, stores, installs, operates, uses, and/or maintains the equipment.

The **Danger, Warning, Caution, and Notice** statements described in this document do not cover all the safety precautions. You also need to comply with relevant international, national, or regional standards and industry practices. **The Company shall not be liable for any consequences that may arise due to violations of safety requirements or safety standards concerning the design, production, and usage of the equipment.**

The equipment shall be used in an environment that meets the design specifications. Otherwise, the equipment may be faulty, malfunctioning, or damaged, which is not covered under the warranty. The Company shall not be liable for any property loss, personal injury, or even death caused thereby.

Comply with applicable laws, regulations, standards, and specifications during transportation, storage, installation, operation, use, and maintenance.

Do not perform reverse engineering, decompilation, disassembly, adaptation, implantation, or other derivative operations on the equipment software. Do not study the internal implementation logic of the equipment, obtain the source code of the equipment software, violate intellectual property rights, or disclose any of the performance test results of the equipment software.

The Company shall not be liable for any of the following circumstances or their consequences:

- The equipment is damaged due to force majeure such as earthquakes, floods, volcanic eruptions, debris flows, lightning strikes, fires, wars, armed conflicts, typhoons, hurricanes, tornadoes, and other extreme weather conditions.
- The equipment is operated beyond the conditions specified in this document.

- The equipment is installed or used in environments that do not comply with international, national, or regional standards.
- The equipment is installed or used by unqualified personnel.
- You fail to follow the operation instructions and safety precautions on the product and in the document.
- You remove or modify the product or modify the software code without authorization.
- You or a third party authorized by you cause the equipment damage during transportation.
- The equipment is damaged due to storage conditions that do not meet the requirements specified in the product document.
- You fail to prepare materials and tools that comply with local laws, regulations, and related standards.
- The equipment is damaged due to your or a third party's negligence, intentional breach, gross negligence, or improper operations, or other reasons not related to the Company.

1.1 Personal Safety

 **DANGER**

Ensure that power is off during installation. Do not install or remove a cable with power on. Transient contact between the core of the cable and the conductor will cause electric arcs, sparks, fire, or explosion, which may result in personal injury.

 **DANGER**

Non-standard and improper operations on the energized equipment may cause fire, electric shocks, or explosion, resulting in property damage, personal injury, or even death.

 **DANGER**

Before operations, remove conductive objects such as watches, bracelets, bangles, rings, and necklaces to prevent electric shocks.

 **DANGER**

During operations, use dedicated insulated tools to prevent electric shocks or short circuits. The dielectric withstanding voltage level must comply with local laws, regulations, standards, and specifications.

⚠ DANGER

During operations, wear personal protective equipment such as protective clothing, insulated shoes, goggles, safety helmets, and insulated gloves.

Figure 1-1 Personal protective equipment

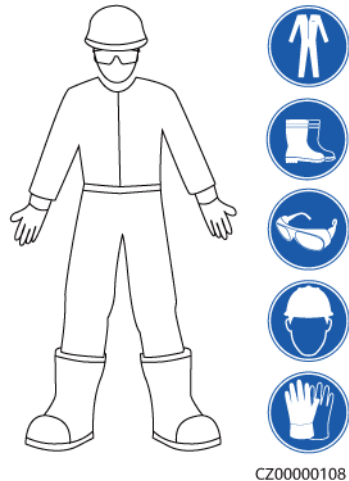

General Requirements

- Do not stop protective devices. Pay attention to the warnings, cautions, and related precautionary measures in this document and on the equipment.
- If there is a likelihood of personal injury or equipment damage during operations, immediately stop, report the case to the supervisor, and take feasible protective measures.
- Do not power on the equipment before it is installed or confirmed by professionals.
- Do not touch the power supply equipment directly or with conductors such as damp objects. Before touching any conductor surface or terminal, measure the voltage at the contact point to ensure that there is no risk of electric shock.
- Do not touch operating equipment because the enclosure is hot.
- In the case of a fire, immediately leave the building or the equipment area and activate the fire alarm or call emergency services. Do not enter the affected building or equipment area under any circumstances.

Personnel Requirements

- Only professionals and trained personnel are allowed to operate the equipment.
 - Professionals: personnel who are familiar with the working principles and structure of the equipment, trained or experienced in equipment operations and are clear of the sources and degree of various potential hazards in equipment installation, operation, maintenance
 - Trained personnel: personnel who are trained in technology and safety, have required experience, are aware of possible hazards on themselves in

certain operations, and are able to take protective measures to minimize the hazards on themselves and other people

- Personnel who plan to install or maintain the equipment must receive adequate training, be able to correctly perform all operations, and understand all necessary safety precautions and local relevant standards.
- Only qualified professionals or trained personnel are allowed to install, operate, and maintain the equipment.
- Only qualified professionals are allowed to remove safety facilities and inspect the equipment.
- Personnel who will perform special tasks such as electrical operations, working at heights, and operations of special equipment must possess the required local qualifications.
- Only authorized professionals are allowed to replace the equipment or components (including software).
- Only personnel who need to work on the equipment are allowed to access the equipment.

1.2 Electrical Safety

 **DANGER**

Before connecting cables, ensure that the equipment is intact. Otherwise, electric shocks or fire may occur.

 **DANGER**

Non-standard and improper operations may result in fire or electric shocks.

 **DANGER**

Prevent foreign matter from entering the equipment during operations. Otherwise, equipment short-circuits or damage, load power derating, power failure, or personal injury may occur.

 **WARNING**

For the equipment that needs to be grounded, install the ground cable first when installing the equipment and remove the ground cable last when removing the equipment.

General Requirements

- Follow the procedures described in the document for installation, operation, and maintenance. Do not reconstruct or alter the equipment, add components, or change the installation sequence without permission.
- Obtain approval from the national or local electric utility company before connecting the equipment to the grid.
- Observe the power plant safety regulations, such as the operation and work ticket mechanisms.
- Install temporary fences or warning ropes and hang "No Entry" signs around the operation area to keep unauthorized personnel away from the area.
- Before installing or removing power cables, turn off the switches of the equipment and its upstream and downstream switches.
- If any liquid is detected inside the equipment, disconnect the power supply immediately and do not use the equipment.
- Before performing operations on the equipment, check that all tools meet the requirements and record the tools. After the operations are complete, collect all of the tools to prevent them from being left inside the equipment.
- Before installing power cables, check that cable labels are correct and cable terminals are insulated.
- When installing the equipment, use a torque tool of a proper measurement range to tighten the screws. When using a wrench to tighten the screws, ensure that the wrench does not tilt and the torque error does not exceed 10% of the specified value.
- Ensure that bolts are tightened with a torque tool and marked in red and blue after double-check. Installation personnel mark tightened bolts in blue. Quality inspection personnel confirm that the bolts are tightened and then mark them in red. (The marks must cross the edges of the bolts.)

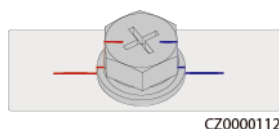

- After the installation is complete, ensure that protective cases, insulation tubes, and other necessary items for all electrical components are in position to avoid electric shocks.
- If the equipment has multiple inputs, disconnect all the inputs before operating the equipment.
- Before maintaining a downstream electrical or power distribution device, turn off the output switch on the power supply equipment.
- During equipment maintenance, attach "Do not switch on" labels near the upstream and downstream switches or circuit breakers as well as warning signs to prevent accidental connection. The equipment can be powered on only after troubleshooting is complete.
- If fault diagnosis and troubleshooting need to be performed after power-off, take the following safety measures: Disconnect the power supply. Check whether the equipment is live. Install a ground cable. Hang warning signs and set up fences.
- Do not open equipment panels.

- Check equipment connections periodically, ensuring that all screws are securely tightened.
- Only qualified professionals can replace a damaged cable.
- Do not scrawl, damage, or block any labels or nameplates on the equipment. Promptly replace labels that have worn out.
- Do not use solvents such as water, alcohol, or oil to clean electrical components inside or outside of the equipment.
- Do not cut the optimizer cables, as this will void the warranty.
- The output wiring terminals of the optimizer are not hot-swappable. If the terminals are hot-swapped, the optimizer may be damaged.

Grounding

- Ensure that the grounding impedance of the equipment complies with local electrical standards.
- Ensure that the equipment is connected permanently to the protective ground. Before operating the equipment, check its electrical connection to ensure that it is reliably grounded.
- Do not work on the equipment in the absence of a properly installed ground conductor.
- Do not damage the ground conductor.
- For the equipment that uses a three-pin socket, ensure that the ground terminal in the socket is connected to the protective ground point.
- If high touch current may occur on the equipment, ground the protective ground terminal on the equipment enclosure before connecting the power supply; otherwise, electric shock as a result of touch current may occur.

Cabling Requirements

- When selecting, installing, and routing cables, follow local safety regulations and rules.
- When routing power cables, ensure that there is no coiling or twisting. Do not join or weld power cables. If necessary, use a longer cable.
- Ensure that all cables are properly connected and insulated, and meet specifications.
- Ensure that the slots and holes for routing cables are free from sharp edges, and that the positions where cables are routed through pipes or cable holes are equipped with cushion materials to prevent the cables from being damaged by sharp edges or burrs.
- Ensure that cables of the same type are bound together neatly and straight and that the cable sheath is intact. When routing cables of different types, ensure that they are away from each other without entanglement and overlapping.
- When cable connection is completed or paused for a short period of time, seal the cable holes with sealing putty immediately to prevent small animals or moisture from entering.
- Secure buried cables using cable supports and cable clips. Ensure that the cables in the backfill area are in close contact with the ground to prevent cable deformation or damage during backfilling.

- If the external conditions (such as the cable layout or ambient temperature) change, verify the cable usage in accordance with the IEC-60364-5-52 or local laws and regulations. For example, check that the current-carrying capacity meets requirements.
- When routing cables, reserve at least 30 mm clearance between the cables and heat-generating components or areas. This prevents deterioration or damage to the cable insulation layer.
- When the temperature is low, violent impact or vibration may damage the plastic cable sheathing. To ensure safety, comply with the following requirements:
 - Cables can be laid or installed only when the temperature is higher than 0°C. Handle cables with caution, especially at a low temperature.
 - Cables stored at below 0°C must be stored at room temperature for more than 24 hours before they are laid out.
- Do not perform any improper operations, for example, dropping cables directly from a vehicle. Otherwise, the cable performance may deteriorate due to cable damage, which affects the current-carrying capacity and temperature rise.

ESD

NOTICE

The static electricity generated by human bodies may damage the electrostatic-sensitive components on boards, for example, the large-scale integrated (LSI) circuits.

- When touching the equipment and handling boards, modules with exposed circuit boards, or application-specific integrated circuits (ASICs), observe ESD protection regulations and wear ESD clothing and ESD gloves or a well-grounded ESD wrist strap.

Figure 1-2 Wearing an ESD wrist strap

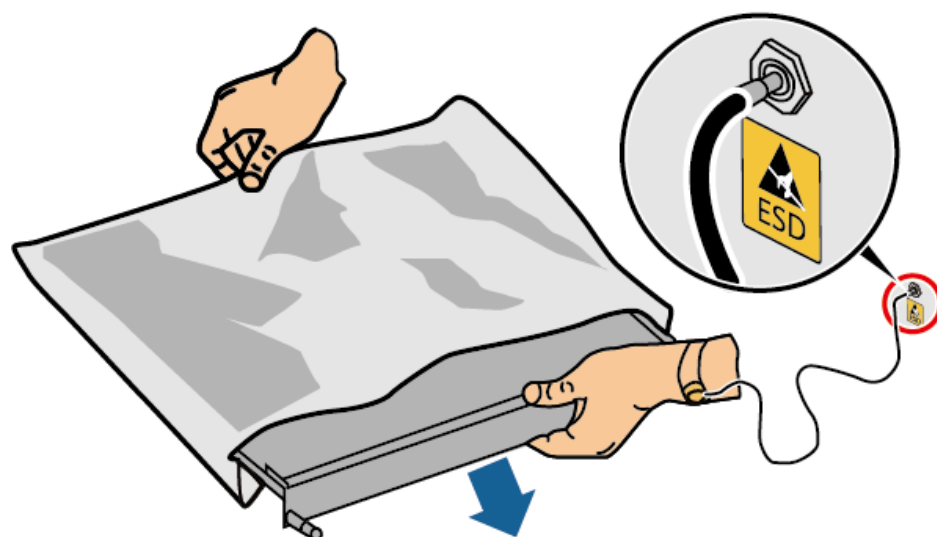

DC15000001

- When holding a board or a module with exposed circuit boards, hold its edge without touching any components. Do not touch the components with bare hands.
- Package boards or modules with ESD packaging materials before storing or transporting them.

1.3 Environment Requirements

 **DANGER**

Do not expose the equipment to flammable or explosive gas or smoke. Do not perform any operation on the equipment in such environments.

 **DANGER**

Do not store any flammable or explosive materials in the equipment area.

 **DANGER**

Do not place the equipment near heat sources or fire sources, such as smoke, candles, heaters, or other heating devices. Overheat may damage the equipment or cause a fire.

 **WARNING**

Install the equipment in an area far away from liquids. Do not install it under areas prone to condensation, such as under water pipes and air exhaust vents, or areas prone to water leakage, such as air conditioner vents, ventilation vents, or feeder windows of the equipment room. Ensure that no liquid enters the equipment to prevent faults or short circuits.

 **WARNING**

To prevent damage or fire due to high temperature, ensure that the ventilation vents or heat dissipation systems are not obstructed or covered by other objects while the equipment is running.

General Requirements

- Ensure that the equipment is stored in a clean, dry, and well ventilated area with proper temperature and humidity and is protected from dust and condensation.

- Keep the installation and operating environments of the equipment within the allowed ranges. Otherwise, its performance and safety will be compromised.
- Do not install, use, or operate outdoor equipment and cables (including but not limited to moving equipment, operating equipment and cables, inserting connectors to or removing connectors from signal ports connected to outdoor facilities, working at heights, performing outdoor installation, and opening doors) in harsh weather conditions such as lightning, rain, snow, and level 6 or stronger wind.
- Do not install the equipment in an environment with direct sunlight, dust, smoke, volatile or corrosive gases, infrared and other radiations, organic solvents, or salty air.
- Do not install the equipment in an environment with conductive metal or magnetic dust.
- Do not install the equipment in an area conducive to the growth of microorganisms such as fungus or mildew.
- Do not install the equipment in an area with strong vibration, noise, or electromagnetic interference.
- Ensure that the site complies with local laws, regulations, and related standards.
- Ensure that the ground in the installation environment is solid, free from spongy or soft soil, and not prone to subsidence. The site must not be located in a low-lying land prone to water or snow accumulation, and the horizontal level of the site must be above the highest water level of that area in history.
- Do not install the equipment in a position that may be submerged in water.
- If the equipment is installed in a place with abundant vegetation, in addition to routine weeding, harden the ground underneath the equipment using cement or gravel.
- Do not install the equipment outdoors in salt-affected areas because it may be corroded. A salt-affected area refers to the region within 500 m of the coast or prone to sea breeze. Regions prone to sea breeze vary with weather conditions (such as typhoons and monsoons) or terrains (such as dams and hills).
- Before installation, operation, and maintenance, clean up any water, ice, snow, or other foreign objects on the top of the equipment.
- When installing the equipment, ensure that the installation surface is solid enough to bear the weight of the equipment.
- After installing the equipment, remove the packing materials such as cartons, foam, plastics, and cable ties from the equipment area.

1.4 Mechanical Safety

 **DANGER**

When working at heights, wear a safety helmet and safety harness or waist belt and fasten it to a solid structure. Do not mount it on an insecure moveable object or metal object with sharp edges. Make sure that the hooks will not slide off.

 **WARNING**

Ensure that all necessary tools are ready and inspected by a professional organization. Do not use tools that have signs of scratches or fail to pass the inspection or whose inspection validity period has expired. Ensure that the tools are secure and not overloaded.

 **WARNING**

Do not drill holes into the equipment. Doing so may affect the sealing performance and electromagnetic containment of the equipment and damage components or cables inside. Metal shavings from drilling may short-circuit boards inside the equipment.

General Requirements

- Repaint any paint scratches caused during equipment transportation or installation in a timely manner. Equipment with scratches must not be exposed for an extended period of time.
- Do not perform operations such as arc welding and cutting on the equipment without evaluation by the Company.
- Do not install other devices on the top of the equipment without evaluation by the Company.
- When performing operations over the top of the equipment, take measures to protect the equipment against damage.
- Use correct tools and operate them in the correct way.

Moving Heavy Objects

- Be cautious to prevent injury when moving heavy objects.



< 18 kg
(< 40 lbs)



18–32 kg
(40–70 lbs)



32–55 kg
(70–121 lbs)

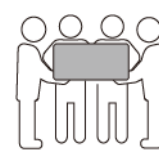

55–68 kg
(121–150 lbs)



> 68 kg
(> 150 lbs)

CZ0000110

- If multiple persons need to move a heavy object together, determine the manpower and work division with consideration of height and other conditions to ensure that the weight is equally distributed.
- If two persons or more move a heavy object together, ensure that the object is lifted and landed simultaneously and moved at a uniform pace under the supervision of one person.
- Wear personal protective gears such as protective gloves and shoes when manually moving the equipment.
- To move an object by hand, approach to the object, squat down, and then lift the object gently and stably by the force of the legs instead of your back. Do not lift it suddenly or turn your body around.

- Do not quickly lift a heavy object above your waist. Place the object on a workbench that is half-waist high or any other appropriate place, adjust the positions of your palms, and then lift it.
- Move a heavy object stably with balanced force at an even and low speed. Put down the object stably and slowly to prevent any collision or drop from scratching the surface of the equipment or damaging the components and cables.
- When moving a heavy object, be aware of the workbench, slope, staircase, and slippery places. When moving a heavy object through a door, ensure that the door is wide enough to move the object and avoid bumping or injury.
- When transferring a heavy object, move your feet instead of turning your waist around. When lifting and transferring a heavy object, ensure that your feet point to the target direction of movement.
- When transporting the equipment using a pallet truck or forklift, ensure that the tynes are properly positioned so that the equipment does not topple. Before moving the equipment, secure it to the pallet truck or forklift using ropes. When moving the equipment, assign dedicated personnel to take care of it.
- Choose sea or roads in good conditions for transportation. Do not transport the equipment by railway or air. Avoid tilt or jolt during transportation.

Working at Heights

- Any operations performed 2 m or higher above the ground shall be supervised properly.
- Only trained and qualified personnel are allowed to work at heights.
- Do not work at heights when steel pipes are wet or other risky situations exist. After the preceding conditions no longer exist, the safety owner and relevant technical personnel need to check the involved equipment. Operators can begin working only after safety is confirmed.
- Set a restricted area and prominent signs for working at heights to warn away irrelevant personnel.
- Set guard rails and warning signs at the edges and openings of the area involving working at heights to prevent falls.
- Do not pile up scaffolding, springboards, or other objects on the ground under the area involving working at heights. Do not allow people to stay or pass under the area involving working at heights.
- Carry operation machines and tools properly to prevent equipment damage or personal injury caused by falling objects.
- Personnel involving working at heights are not allowed to throw objects from the height to the ground, or vice versa. Objects shall be transported by slings, hanging baskets, aerial work platforms, or cranes.
- Do not perform operations on the upper and lower layers at the same time. If unavoidable, install a dedicated protective shelter between the upper and lower layers or take other protective measures. Do not pile up tools or materials on the upper layer.
- Dismantle the scaffolding from top down after finishing the job. Do not dismantle the upper and lower layers at the same time. When removing a part, ensure that other parts will not collapse.

- Ensure that personnel working at heights strictly comply with the safety regulations. The Company is not responsible for any accident caused by violation of the safety regulations on working at heights.
- Behave cautiously when working at heights. Do not rest at heights.

Using Ladders

- Use wooden or insulated ladders when you need to perform live-line working at heights.
- Platform ladders with protective rails are preferred. Single ladders are not recommended.
- Before using a ladder, check that it is intact and confirm its load bearing capacity. Do not overload it.
- Ensure that the ladder is securely positioned and held firm.



CZ00000107

- When climbing up the ladder, keep your body stable and your center of gravity between the side rails, and do not overreach to the sides.
- When a step ladder is used, ensure that the pull ropes are secured.
- If a single ladder is used, the recommended angle for the ladder against the floor is 75 degrees, as shown in the following figure. A square can be used to measure the angle.

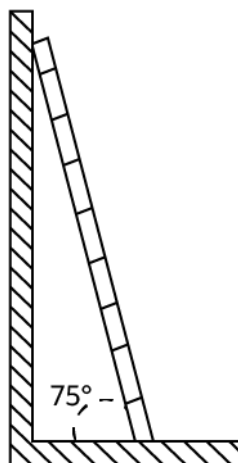

PI025C0008

- If a single ladder is used, ensure that the wider end of the ladder is at the bottom, and take protective measures to prevent the ladder from sliding.
- If a single ladder is used, do not climb higher than the fourth rung of the ladder from the top.

- If you use a single ladder to climb up to a platform, ensure that the ladder is at least 1 m higher than the platform.

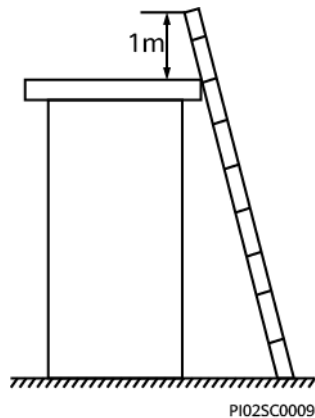

Drilling Holes

- Obtain consent from the customer and contractor before drilling holes.
- Wear protective equipment such as safety goggles and protective gloves when drilling holes.
- To avoid short circuits or other risks, do not drill holes into buried pipes or cables.
- When drilling holes, protect the equipment from shavings. After drilling, clean up any shavings.

2 Product Introduction

2.1 Overview

The smart PV optimizer is a DC to DC converter which implements maximum power point tracking (MPPT) of each PV module to improve the energy yield of the PV system. It enables module-level shutdown and monitoring, and supports long-string design.

Functions and Features

- Module-level MPPT: Implements maximum power point tracking of each PV module to improve the energy yield of the PV system.
- Module-level shutdown: Adjusts the module output voltage to a safe range when the output is disconnected or the inverter shuts down.
- Module-level monitoring: Monitors the operating status of each PV module.
- Long PV string supported: If all PV modules are configured with optimizers, a PV string can contain more PV modules than conventional PV strings.

Model

This document involves the following product models:

- MERC-1300W-P
- MERC-1100W-P

Figure 2-1 Model description (MERC-1300W-P optimizer is used as an example)

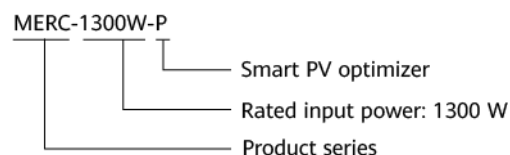

Optimizer Model	Part No.	Rated Input Power	Input Cable Length	Output Cable Length
MERC-1300W-P (Short input power cables)	02314APY	1300 W	0.1 m	5.1 m (negative) +0.1 m (positive)
MERC-1300W-P (Long input power cables)	02314AQB	1300 W	1.3 m	2.9 m (negative) +0.1 m (positive)
MERC-1100W-P (Short input power cables)	02314APY-001	1100 W	0.1 m	5.1 m (negative) +0.1 m (positive)
MERC-1100W-P (Long input power cables)	02314AQB-001	1100 W	1.3 m	2.9 m (negative) +0.1 m (positive)

2.2 Structure

Optimizer Ports

Figure 2-2 Ports

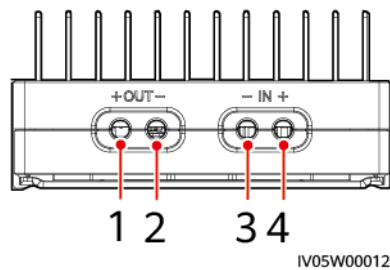

(1) Output port (positive)

(2) Output port (negative)

(3) Input port (negative)

(4) Input port (positive)

Optimizer Dimensions

Figure 2-3 Optimizer dimensions

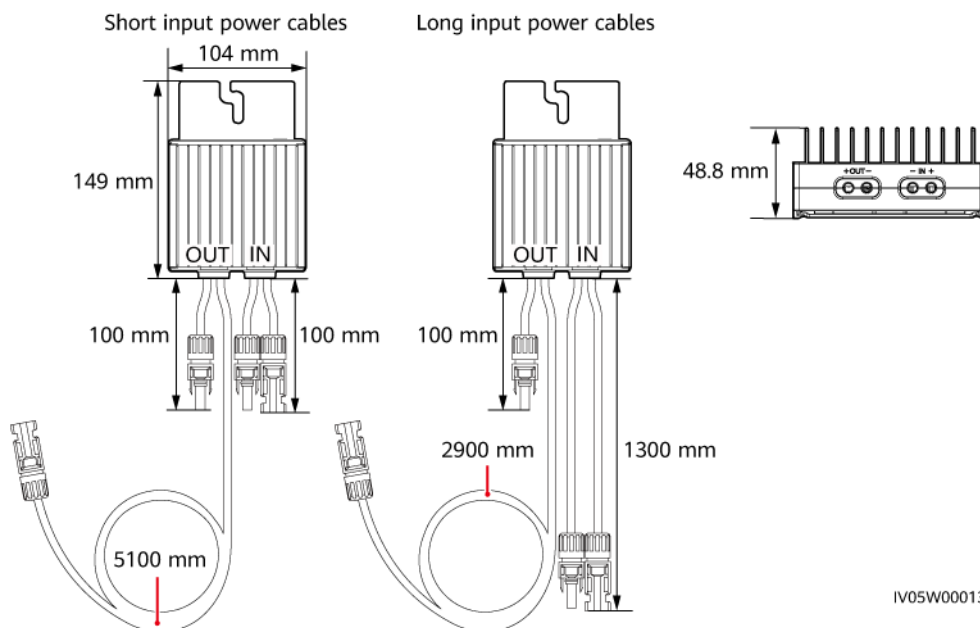

2.3 Configuration Principles

Precautions

- The SUN2000-(600W-P, 450W-P2) and MERC-600W-PA0 cannot be used together with the MERC-(1300W, 1100W)-P.
- Optimizers are not supported in off-grid scenarios.
- Partial configuration is not allowed. All PV modules must be connected to optimizers. Otherwise, the inverter cannot start and serious consequences may occur. The resulting device damage is not covered under any warranty.
- The capacity difference between PV strings connected to the same inverter must be less than or equal to 2 kW
- The number of optimizers supported in a PV string, the upper limit of the string power, and requirements for connecting PV strings in parallel vary according to the inverter model. The configuration principles for different inverter models are as follows.

Configuration Principles (8KTL-50KTL)

NOTE

When the MERC-(1300W, 1100W)-P optimizers are used, only one string can be connected to each MPPT circuit of the inverter.

Table 2-1 Configuration principles

Supported Inverter Model	String Power Upper Limit	Maximum Number of Optimizers Supported in a String	Capacity Ratio Corresponding to String Quantity				Version
			1	2	3	4	
SUN2000-8KTL-M2	20 kW	8-25	0.8-2.0	-	None	None	<ul style="list-style-type: none"> SUN2000 MA V100R001 C00SPC147 or later (M2) SUN2000 MB V200R022 C10SPC100 or later (M5/ZHM5)
SUN2000-10KTL-M2	20 kW	8-25	0.8-2.0	-	None	None	
SUN2000-12KTL-M2/M5/MB0	20 kW	8-25	0.8-1.6	1.6-2.0	None	None	
SUN2000-15KTL-M2/M5/ZHM5/MB0/MB0-ZH	20 kW	8-25	0.8-1.0	1.0-2.0	None	None	
SUN2000-17KTL-M2/M5/ZHM5/MB0/MB0-ZH	20 kW	8-25	0.8-0.9	0.9-2.0	None	None	
SUN2000-20KTL-M2/M5/ZHM5/MB0/MB0-ZH	20 kW	8-25	-	0.8-2.0	None	None	
SUN2000-25KTL-M5/ZHM5/MB0/MB0-ZH	20 kW	8-25	-	0.8-1.6	None	None	
SUN2000-20KTL-M3 (Brazil and Japan)	8 kW	6-25	-	-	0.8-1.0	1.0-1.6	SUN2000MA V100R001C20SPC118 or later
SUN2000-29.9/30KTL-M3	20 kW	8-25	-	0.8-1.0	1.0-2.0	-	
SUN2000-36KTL-M3	20 kW	8-25	-	0.8-0.9	0.9-1.6	1.6-2.0	
SUN2000-40KTL-M3	20 kW	8-25	-	-	0.8-1.0	1.0-2.0	
SUN2000-50KTL-ZHM3/M3/NHM3	20 kW	8-20	-	-	0.8-0.9	0.9-1.6	SUN2000MC V200R023C00SPC100 or later

Configuration Principles (150K)

Based on the recommended number of PV strings (9–12) in the configuration principles, evenly distribute the DC input PV strings on each MPPT circuit. For details about the recommended DC input terminals, see the [SUN5000-150K-MG0 User Manual](#).

NOTE

- When the MERC-(1300W, 1100W)-P optimizers are used, a maximum of two PV strings can be connected to each MPPT circuit of the inverter.
- The PV strings connected in parallel must consist of PV modules of the same model, quantity, direction, and tilt angle. If some PV modules in a PV string are shaded, it is recommended that the PV string be connected to an MPPT circuit separately.

Table 2-2 Configuration Principles

Supported Inverter Models	String Power Upper Limit	Maximum Number of Optimizers Supported in a String	Capacity Ratio Corresponding to String Quantity			
			9	10	11	12
SUN5000-150K-MG0/MG0-ZH	20 kW	12–20	0.8–1.0	1.0–1.1	1.1–1.2	1.2–1.6

2.4 Application Scenarios

Full configuration: All PV modules are connected to optimizers.

In this scenario, the MPPT function, module-level shutdown and monitoring, and long-string design are supported.

NOTE

- An optimizer is delivered with two types of input power cables: long (1300 mm) or short (100 mm) cables. For PV modules with long cables, select optimizers with short cables; for PV modules with short cables, select optimizers with long cables.
- The SUN2000-(600W-P, 450W-P2) cannot be used together with the MERC-(1300W, 1100W)-P.
- To ensure reliable communication between the inverter and optimizers, the AC and DC power cables must be routed in different troughs or pipes with a minimum of 10 cm spacing in between.
- To reduce the impact of electromagnetic interference, the distance between the positive and negative cables of optimizers must be minimized, as shown in the following figure for either a single string installation or a multi-string installation.

Figure 2-4 Required routing

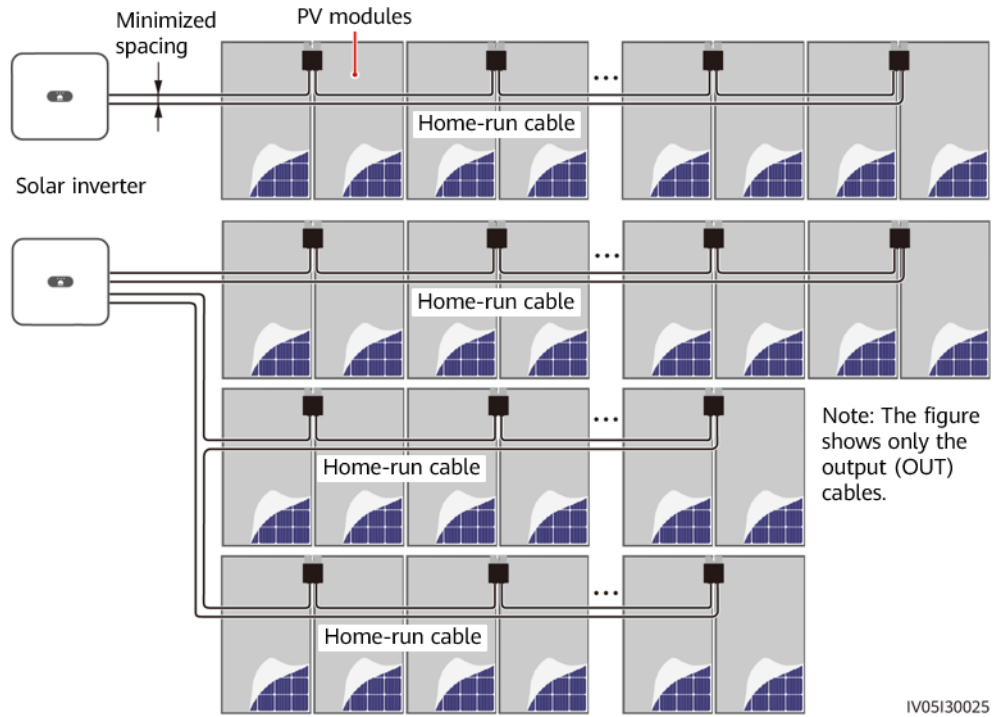
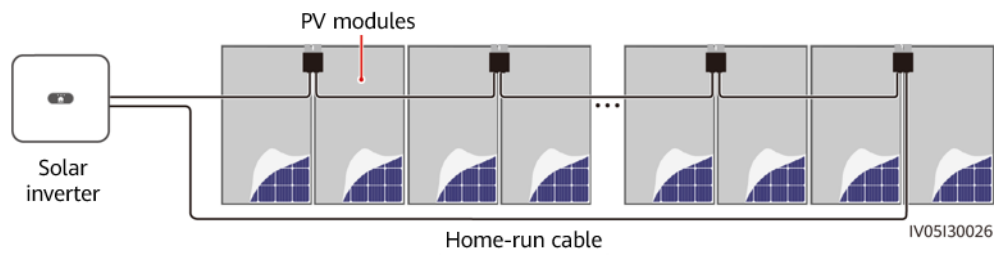

Figure 2-5 Prohibited routing



3 System Maintenance

DANGER

- Wear personal protective equipment and use dedicated insulated tools to avoid electric shocks or short circuits.
 - Do not use wet cloth to clean exposed copper bars or other conductive parts.
-

WARNING

- Before performing maintenance, power off the equipment, follow the instructions on the delayed discharge label, and wait for a period of time as specified to ensure that the equipment is not energized.
-

NOTICE

Before the equipment is put into operation for the first time, ensure that the parameters are set correctly by professional personnel. Incorrect parameter settings may result in noncompliance with local grid connection requirements and affect the normal operations of the equipment.

3.1 Setting the Physical Layout of the Smart PV Optimizers

NOTE

- If smart PV optimizers are configured for PV strings, ensure that the smart PV optimizers have been successfully connected to the SUN2000 before performing the operations in this section.
- Check that the SN labels of smart PV optimizers are correctly attached to the physical layout template.
- Take and save a photo of the physical layout template. Keep your phone parallel to the template and take a photo in landscape mode. Ensure that the four positioning points in the corners are in the frame. Ensure that each QR code is attached within the frame.

Method 1: Setting on the FusionSolar WebUI

NOTE

- If you have uploaded the physical layout template photo on the FusionSolar app, skip the steps of **Manage Drawings > Upload**.

Log in to <https://intl.fusionsolar.huawei.com> to access the WebUI of the FusionSolar Smart PV Management System. On the **Home** page, click the plant name to access the plant page. Choose **Layout > Edit > Manage Drawings > Upload > Identify Drawings > Identify** to create a physical layout as prompted. You can also manually create a physical layout.

Figure 3-1 Physical layout design of PV modules

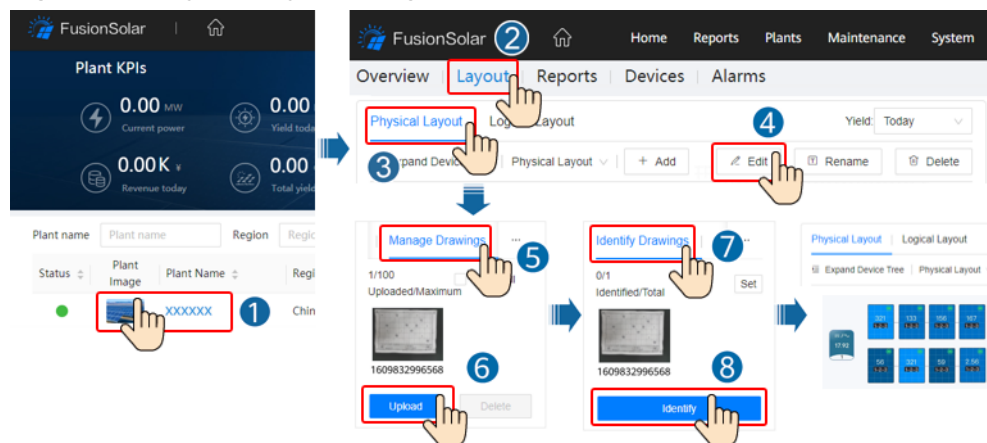

Method 2: Uploading the physical layout template photo on the FusionSolar app

NOTE

- If there are more than 16 photos, upload them on the FusionSolar WebUI.
- If the number of PV modules in the physical layout exceeds 200, edit the physical layout on the FusionSolar WebUI.
- For some unidentified QR codes, log in to the FusionSolar WebUI to manually bind them
- For details about the physical layout of smart PV optimizers, see [FusionSolar App Quick Guide](#). You can scan the QR code to download the quick guide.



To upload the physical layout template photo on the FusionSolar app, log in to the app and tap the plant name on the **Home** screen to access the plant screen. Select **Layout**, tap , and upload the physical layout template photo as prompted. After the upload is complete, tap **Generate Physical Layout > Confirm** to create a physical layout as prompted. You can also manually create a physical layout.

Figure 3-2 Uploading the physical layout template photo on the FusionSolar app



3.2 Detecting Optimizer Disconnection

- Log in to the FusionSolar app and tap the plant name on the **Home** screen to access the plant screen. Choose **Layout**, tap **Disconnection detection** to check optimizer disconnection, and rectify the fault based on the result.

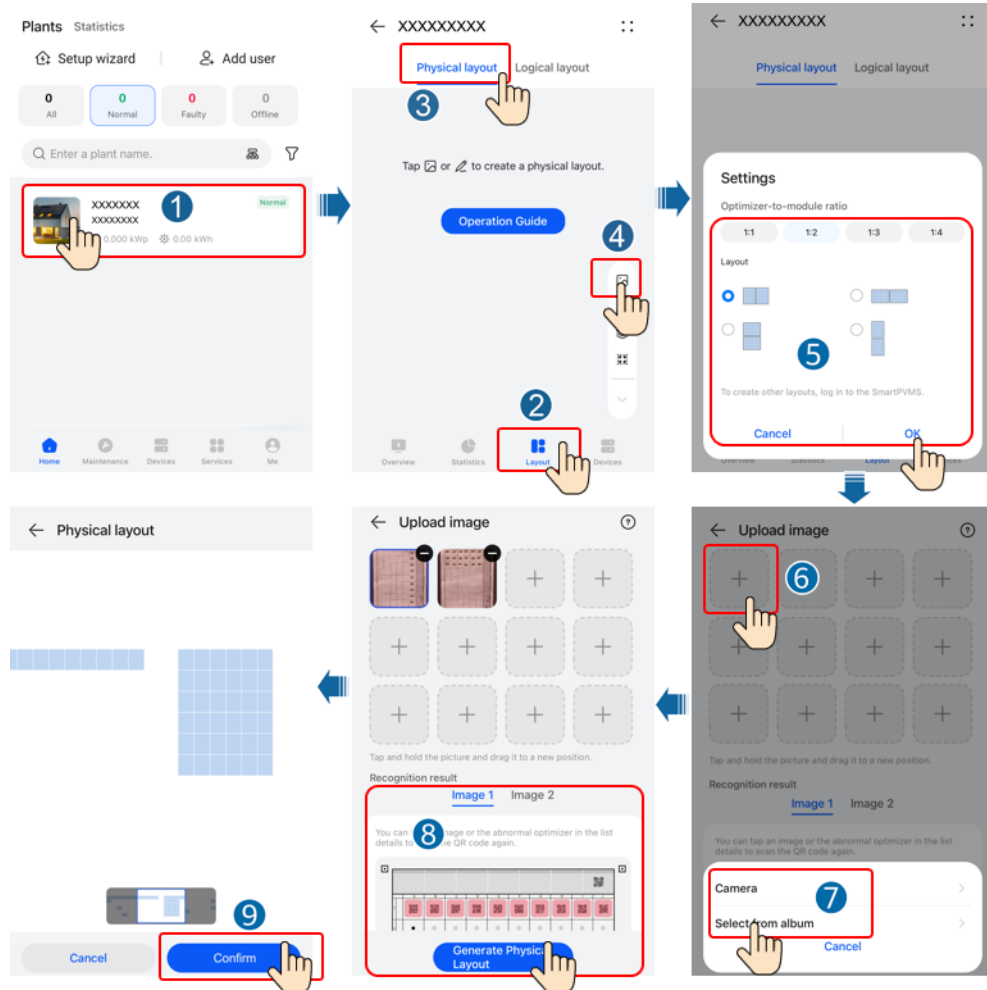
Figure 3-3 Detect optimizer disconnection

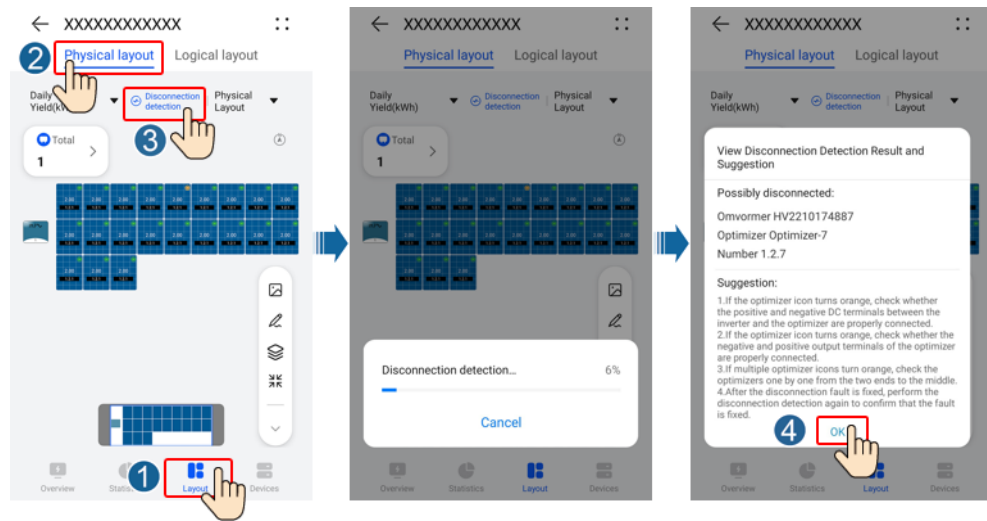

- Log in to <https://intl.fusionsolar.huawei.com> to access the WebUI of the FusionSolar Smart PV Management System. On the **Home** page, click the plant name to access the plant page. Choose **Layout**, tap **Disconnection detection** to check optimizer disconnection, and rectify the fault based on the result.

Figure 3-4 Detect optimizer disconnection

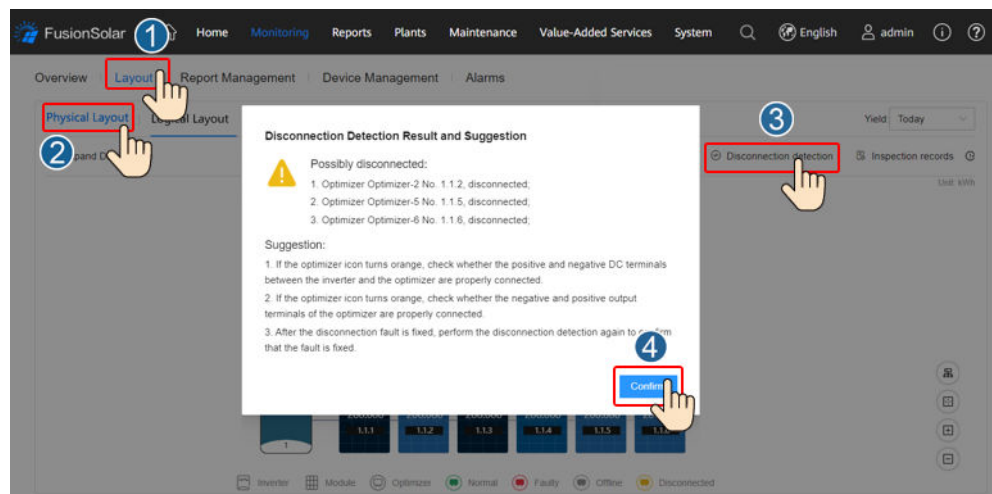

3.3 Rapid Shutdown

When the output is disconnected or the inverter shuts down, the optimizer can adjust the module output voltage to a safe range to ensure the safety of the construction and O&M personnel as well as firefighters.

If optimizers are configured for all PV modules, the PV system can perform a rapid shutdown to decrease the output voltage to below 120 V within 15s and to below 30 V within 30s.

Perform the following steps to trigger a rapid shutdown:

- Method 1: Turn off the AC switch between the inverter and the power grid.
- Method 2: Turn off the DC switch on the inverter.
- Method 3: Connect a switch to the DI and GND ports of the inverter to form a circuit. (For details about the DI port, see the corresponding inverter user manual.) The switch is turned on by default. Turn off the switch to trigger a rapid shutdown.

3.4 Troubleshooting

Table 3-1 Common alarms and troubleshooting measures

Alarm Name	Cause	Suggestions
Input overvoltage	Optimizer input overvoltage occurred.	Check whether the open-circuit voltage of the PV module exceeds the maximum input voltage of the optimizer.
Overtemperature	The optimizer internal temperature is too high.	<ol style="list-style-type: none"> 1. Check the ventilation and ambient temperature at the optimizer installation position. If the ventilation is poor or the ambient temperature exceeds the upper threshold, improve the ventilation and heat dissipation. 2. If the ventilation and ambient temperature are normal, contact your installer.
Internal hardware fault	An internal fault occurred in an optimizer.	Contact your installer.
Output terminal overtemperature	The output terminal temperature of some optimizers is abnormal.	Contact your installer to replace the faulty optimizer and the optimizer connected to the short output cables of the faulty optimizer.
Output backfeed	Optimizer output backfeed occurred.	<ol style="list-style-type: none"> 1. Check whether PV modules are shaded when PV strings are connected in parallel. 2. If the fault persists, contact your installer.

Alarm Name	Cause	Suggestions
Abnormal output voltage	The optimizer output voltage is abnormal.	<ol style="list-style-type: none"> 1. When the sunlight is normal, perform optimizer search again. 2. Check the voltage of the corresponding PV string. If the voltage is greater than 0 V, power off the system and check whether the extension cable of the abnormal optimizer is correctly connected. 3. Check the voltage of the corresponding PV string. If the voltage is 0 V, power off the system and check the cable connection of the PV string. If there is an open circuit, rectify the cable connection of the PV string. If the polarity is incorrect, reconnect the PV string in the correct polarity. After the open circuit or reverse polarity is rectified, power on the system and perform an optimizer search again. If the alarm persists, check whether the extension cable of the abnormal optimizer is correctly connected. 4. If the fault persists, contact your installer. Note: The polarity at both ends of the extension cable must be opposite (one end is a positive connector, and the other is a negative connector). To determine the PV string polarity, see "3 Installing the Optimizer Cables" in the optimizer quick guide.
Upgrade failed	The optimizer software upgrade failed.	<ol style="list-style-type: none"> 1. When the sunlight is normal, perform the optimizer upgrade again. 2. If the fault persists, contact your installer.

 **NOTE**

If the fault persists after all suggested measures listed above are completed, contact your installer.

3.5 Replacing an Optimizer

Prerequisites

- Use dedicated insulation tools, and wear insulation shoes and insulated gloves before performing operations.

- A new smart PV optimizer is available.

Procedure

Step 1 Put on the insulated gloves.

Step 2 Power off the inverter.

Step 3 Disconnect the input terminals of the optimizer.

Step 4 Remove the old optimizer.

1. Record the cable connection positions on the optimizer and disconnect the cables.
2. Loosen the bolt that secures the optimizer and remove the optimizer.

Step 5 Install a new optimizer.

1. Secure the new optimizer to the corresponding bolt and tighten the bolt.
2. Connect the cables to the new optimizer based on the recorded information.

NOTE

If multiple optimizers need to be replaced, record the optimizer numbers.

Step 6 Power on the solar inverter. Log in to the FusionSolar app and tap the plant name on the **Home** screen to access the plant screen. Choose **Devices > Inverter**, select the inverter corresponding to the faulty optimizer, tap **Optimizer Search**, and perform operations as prompted to search for optimizers.

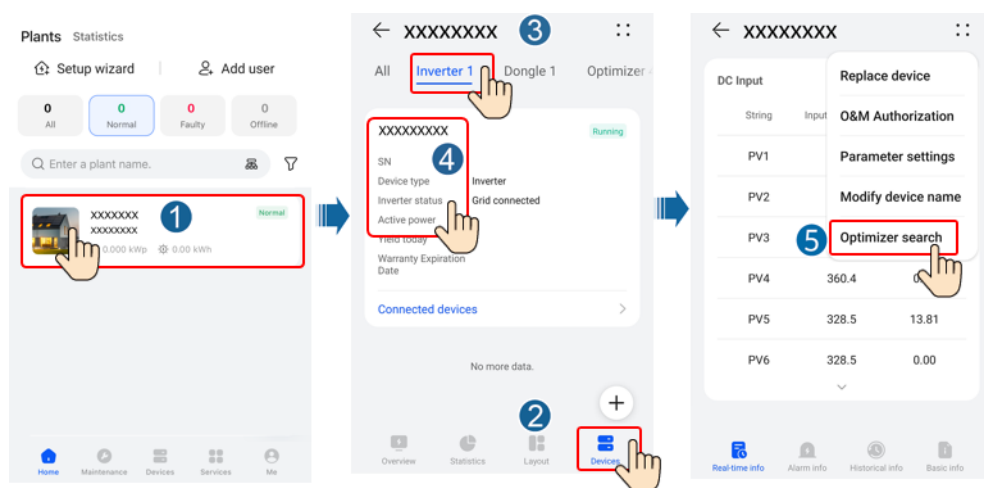

Step 7 Choose **Devices > Connected devices > Optimizer**, tap **Optimizer No.**, select the faulty optimizer, tap **Device Replacement**, and replace the optimizer as prompted.

NOTE

- If *N* optimizers need to be replaced, perform the preceding procedure for *N* times.
- After the optimizer is replaced, the new optimizer automatically inherits the energy yield, physical layout, and logical layout of the faulty optimizer.

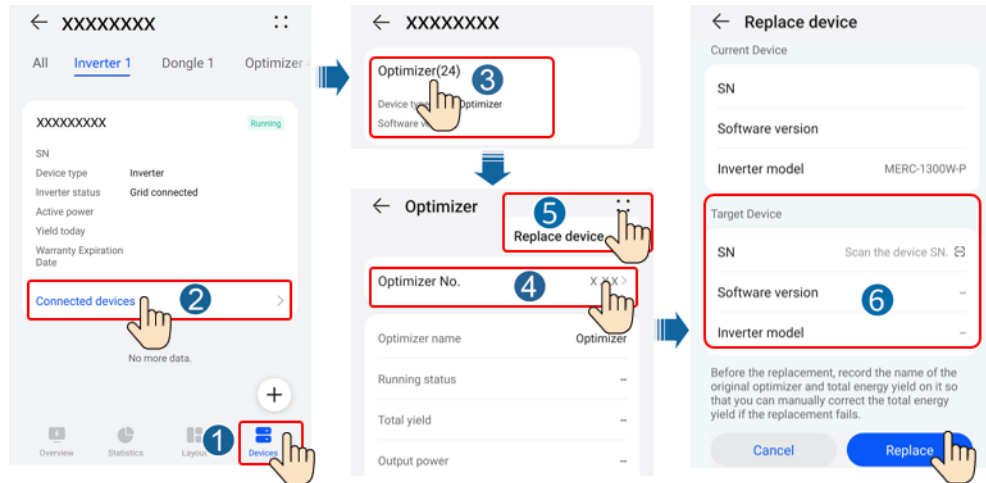

----End

Follow-up Procedure

Pack the faulty component and return it to the local Huawei warehouse.

3.6 Maintaining PV Modules

Log in to the FusionSolar app and tap the plant name on the **Home** screen to access the plant screen. Select **Layout** and quickly identify inefficient PV modules by color in the physical or logical layout.



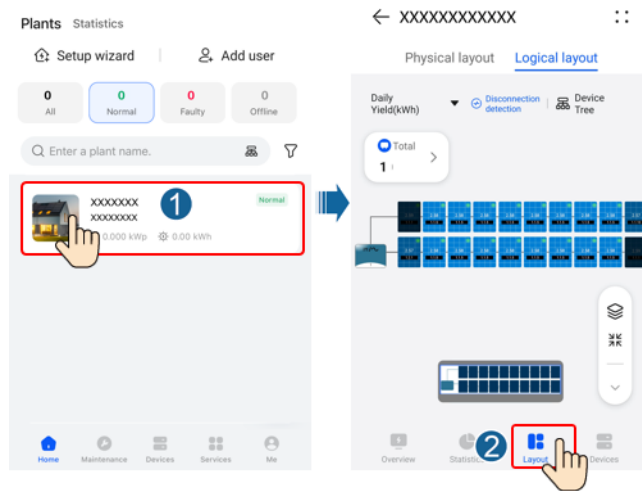

Figure 3-5 Maintaining PV modules



 **NOTE**

- When the power of PV modules under normal irradiance is the same and the colors of PV modules in the layout are similar, the PV modules are normal.
- When the power of PV modules under normal irradiance is the same but the colors of some PV modules are darker than those of the other PV modules in the layout, PV modules with darker colors may be inefficient PV modules if the module surfaces are clean and there is no shading.
- When the power of PV modules under normal irradiance is the same and a 1-to-2 optimizer is connected to only one PV module, the color of this PV module is darker than that of other PV modules.

Table 3-2 PV module colors

Ratio Range (Optimizer Output Power/Optimizer Rated Power)	PV Module Color	Description
0%–20%		PV module power ratio = Optimizer output power/ Optimizer rated power. The color of a PV module depends on the power ratio range. A darker color indicates a smaller power ratio, and vice versa.
20%–40%		
40%–60%		
60%–80%		
80%–100%		

Ratio Range (Optimizer Output Power/Optimizer Rated Power)	PV Module Color	Description
Default color		The rated power of the optimizer cannot be reported or obtained. As a result, the calculation fails.

4 Technical Specifications

Efficiency

Technical Specifications	MERC-1300W-P	MERC-1100W-P
Maximum efficiency	99.5%	
European weighted efficiency	99.0%	

Input

Technical Specifications	MERC-1300W-P	MERC-1100W-P
Rated PV module power	1300 W	1100 W
Maximum PV module power	1365 W	1155 W
Maximum input voltage	125 V	
MPPT voltage range	12.5-105 V	
Maximum short-circuit current	20 A	
Overvoltage level	II	

Output

Technical Specifications	MERC-1300W-P	MERC-1100W-P
Rated output power	1300 W	1100 W
Output voltage	2-80 V	
Maximum output current	22 A	
Output bypass	Yes	
Safe output voltage	Typical value: 1 V	

General Specifications

Technical Specifications	MERC-1300W-P	MERC-1100W-P
Dimensions (H x W x D)	149 mm x 104 mm x 48.8 mm	
Net weight	≤ 1050 g	
DC input and output terminals	Staubli MC4	
Operating temperature ^a	-40°C to +85°C	
Storage temperature	-40°C to +70°C	
Operating humidity	0-100% RH	
Storage humidity	5-95% RH	
Maximum operating altitude	4000 m	
IP rating	IP68	
Installation mode	<ul style="list-style-type: none">● PV module support installation● PV module frame installation	
Note a: When the operating temperature of the optimizer ranges from 70°C to 85°C, the optimizer may shut down for overtemperature protection and report an overtemperature alarm. After the operating temperature decreases, the optimizer automatically recovers with no risk of damage.		

A Acronyms and Abbreviations

D

DC direct current

E

EFT electrical fast transient

EMI electromagnetic interference

EMS electromagnetic susceptibility

ESD electrostatic discharge

M

MPPT maximum power point tracking

R

RE radiated emission

RS radiated susceptibility